

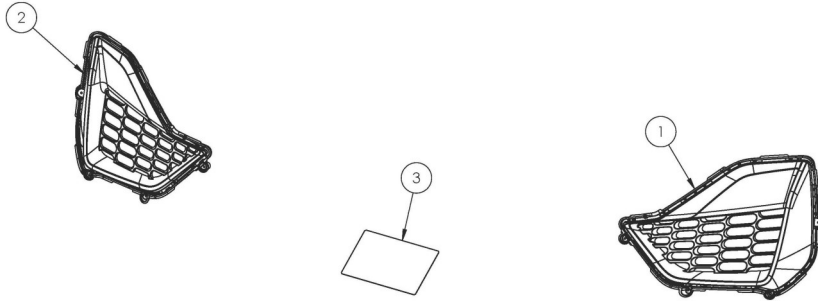

**2024 Ford Mustang  
RTR Corner Grilles  
Part Number 11011.0003.12.A**



**Components Included**

1.	RTR Corner Grille, Left	1
2.	RTR Corner Grille, Right	1
3.	Installation Scan Card	1

These instructions depict an installation being performed on a Mustang GT, Performance Pack 3. While some installation details may vary from model to model, the general procedure remains the same. Disregard any information that does not apply to your model.

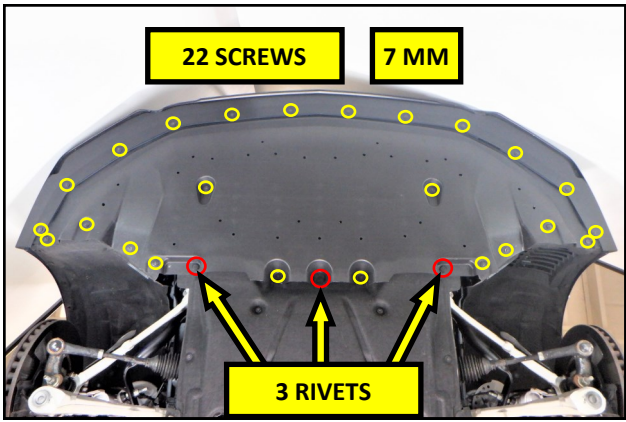

**1.** With the vehicle safely supported on a lift or jack-stands, remove the front wheels and tires. Using a 7mm socket, remove the 22 screws in the debris shield. Pry the center post out of the 3 plastic rivets and remove them. Remove the shield from the vehicle.

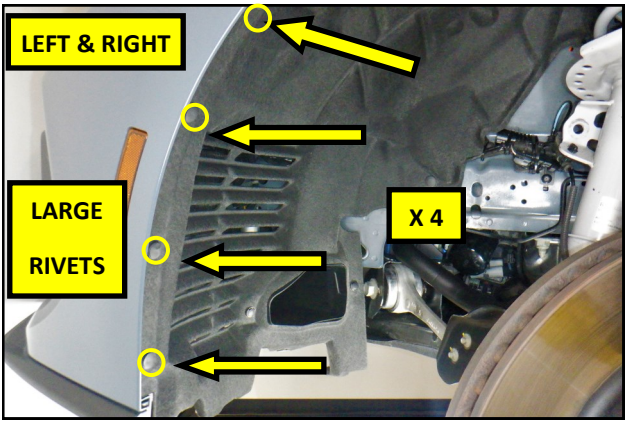

**2.** Remove the 4, large plastic rivets from both of the front fender liners. **NOTE:** This installation will reuse all of the OEM hardware. RTR Advises grouping the hardware by component to avoid confusion during reassembly.

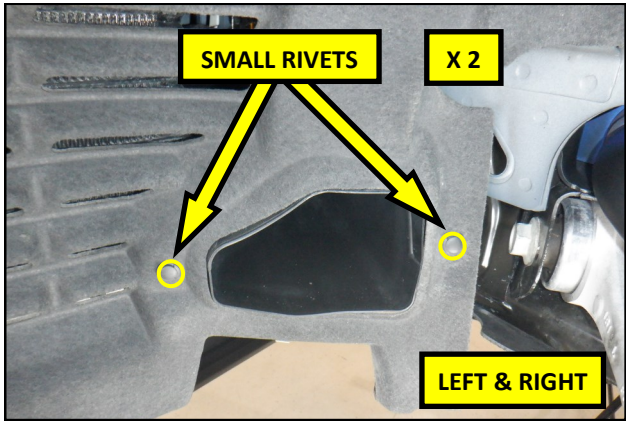

**3.** Remove the 2, small rivets in the brake cooling ducts, if so equipped.

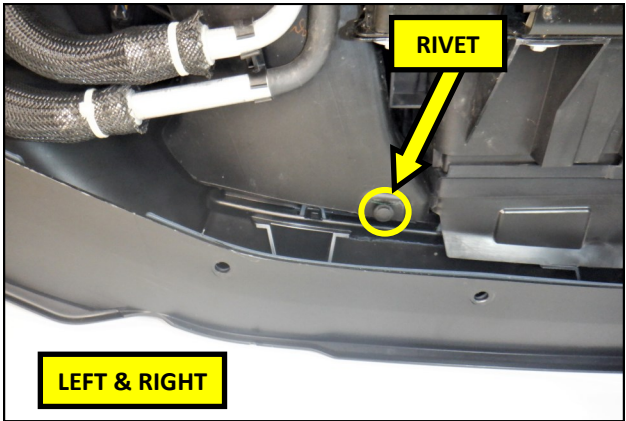

**4.** Remove the single plastic rivet in the cooling duct inlets.

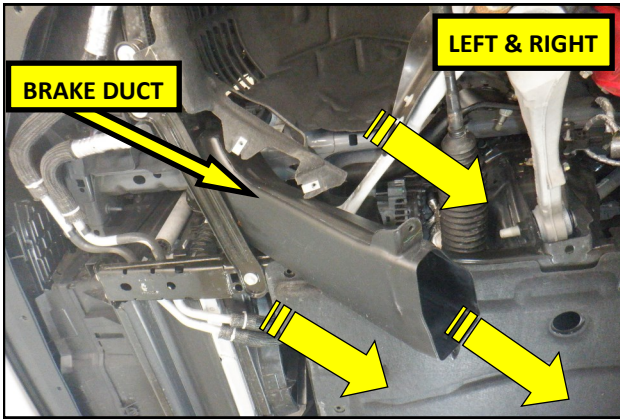

5. Remove the brake cooling ducts from the vehicle and set them aside.

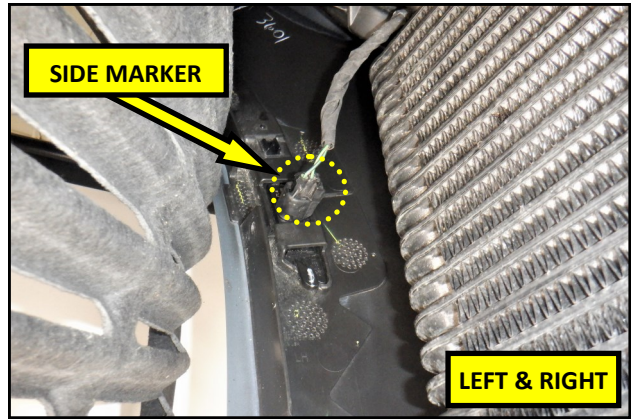

6. Locate and disconnect the side marker lights inside the bumper cover.

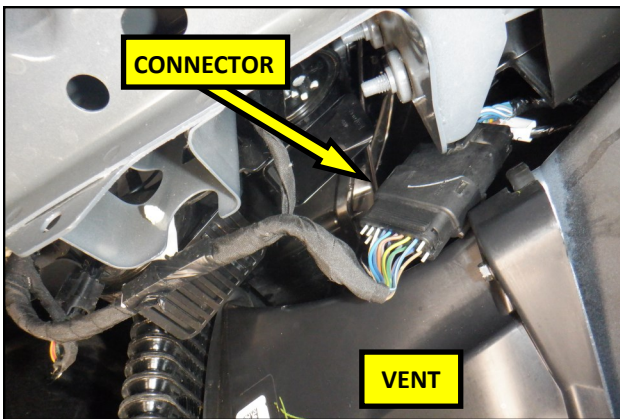

7. Locate and disconnect the bumper wiring harness.  
**NOTE:** There is only one large multi wire harness connected to the bumper cover and it resides near the driver side, lower bumper vent.

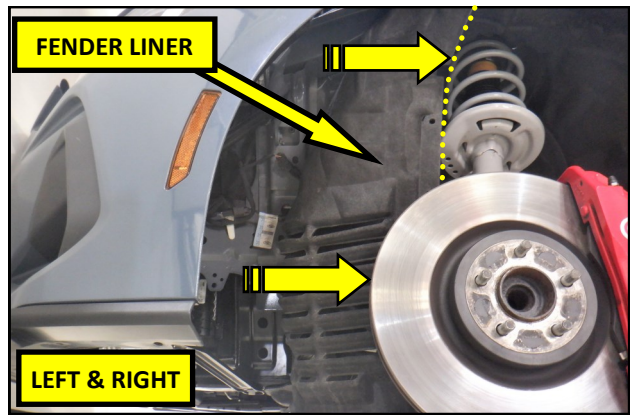

8. Gently fold the fender liners rearward, and behind the brake rotors as shown.

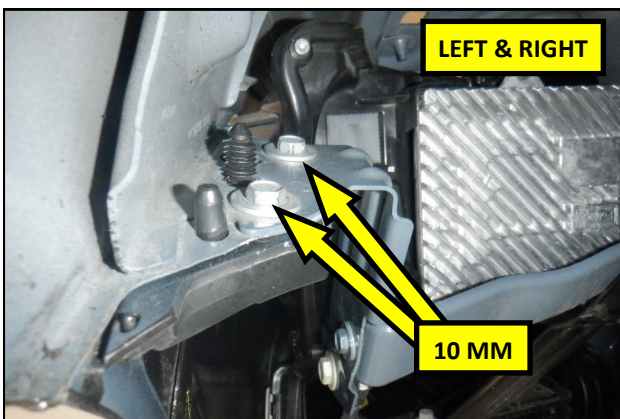

9. Using a 10 mm socket, remove the two bolts securing the bumper cover to fender. Repeat this step on the opposite side of the vehicle.

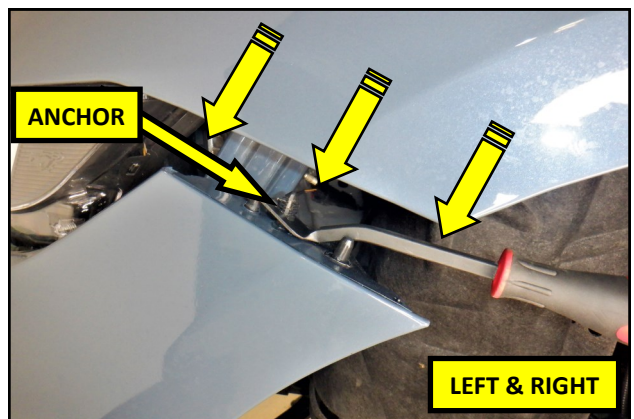

10. Using a panel clip removal tool, or equivalent, pry the fir tree anchors out of the fenders and separate the bumper cover from the fenders as shown.

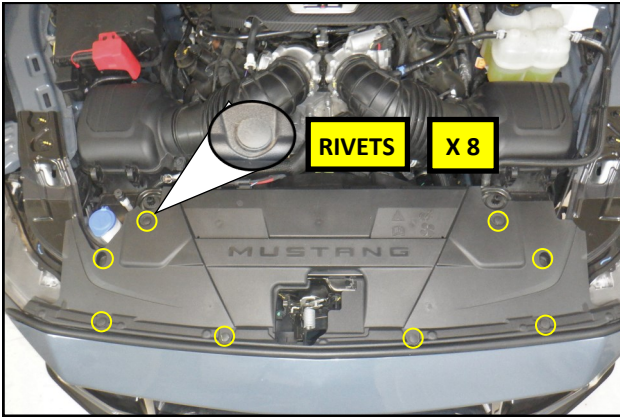

**11.** Remove the eight plastic rivets in the core support cover and remove the cover from the vehicle.

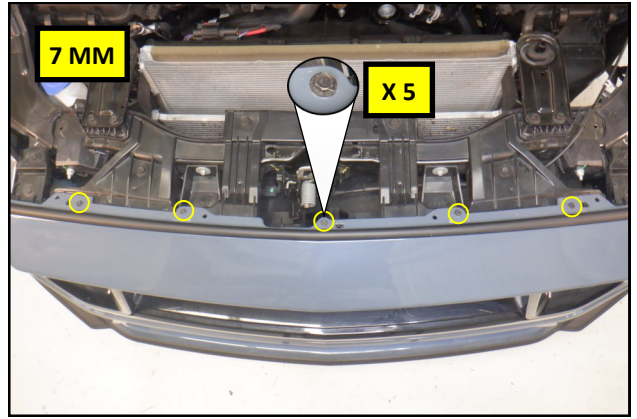

**12.** Using a 7 mm socket, remove the five screws along the upper bumper cover.

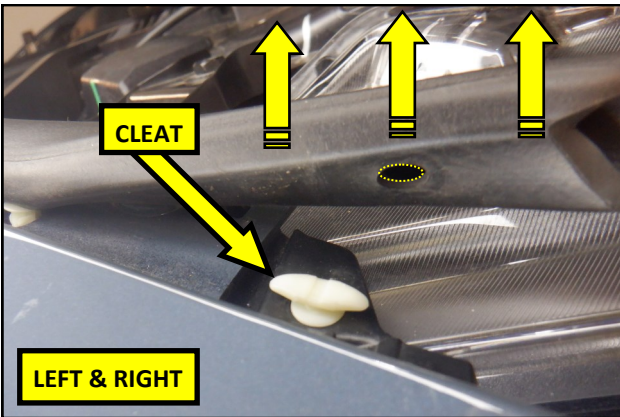

**13.** Carefully remove the weatherstrip foam from the cleat in the core support on both sides of the vehicle.

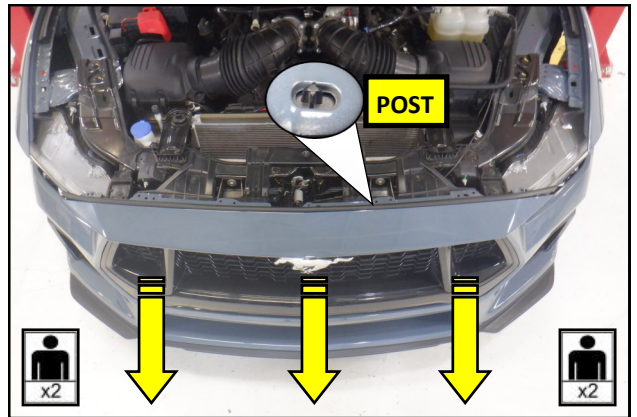

**14.** With the help of an assistant, lift the bumper cover up and over the core support posts and remove the cover from the vehicle. Place the cover, face down, onto a padded work surface.

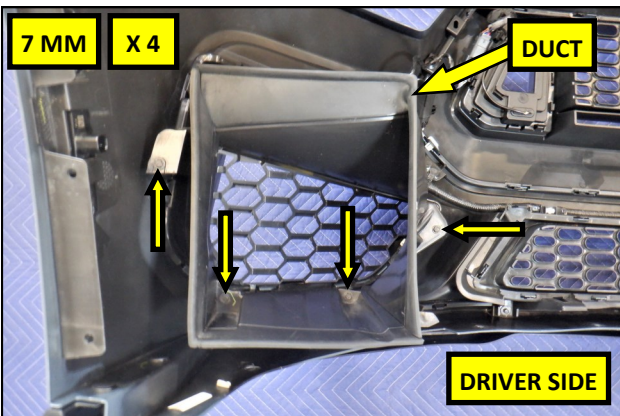

**15.** Using a 7 mm socket, remove the 4 screws securing the cooling duct to the corner grille. Remove the duct and set it aside.

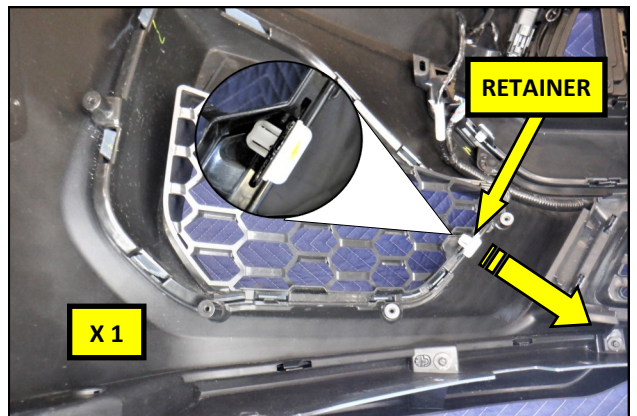

**16.** Depress the tab on the retainer clip and remove it from the bumper cover.

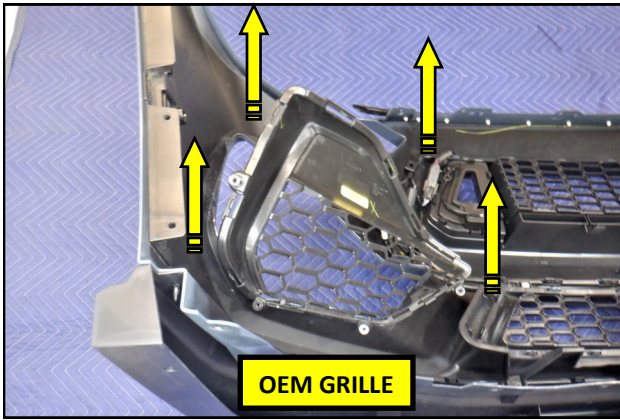

17. Depress the bumper cover tabs, one by one, and remove the OEM corner grille from the bumper cover.

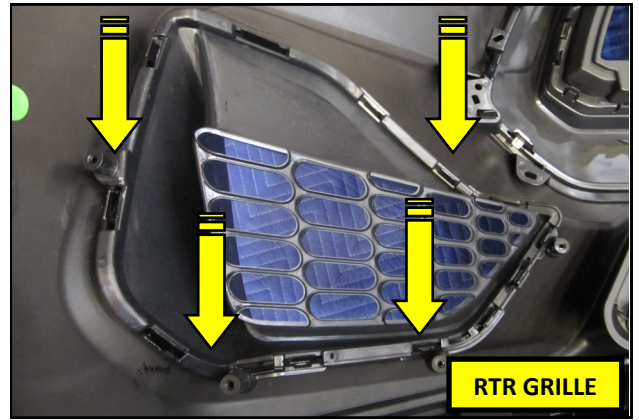

18. Carefully align the cover tabs with the Grille slots and install the RTR Corner Grille. Apply firm pressure around each tab until a distinct click can be heard, indicating full engagement.

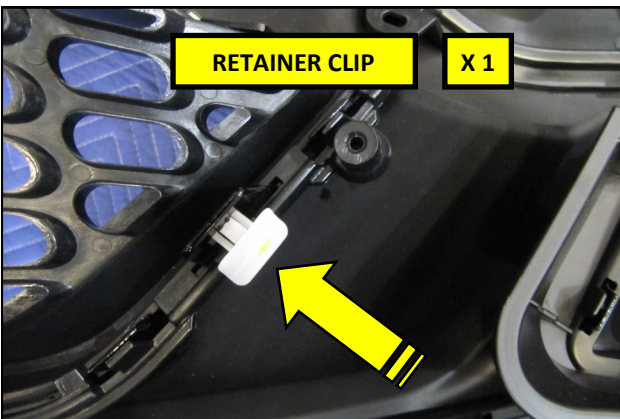

19. Reinstall the retainer clip from step 16 into the bumper cover.

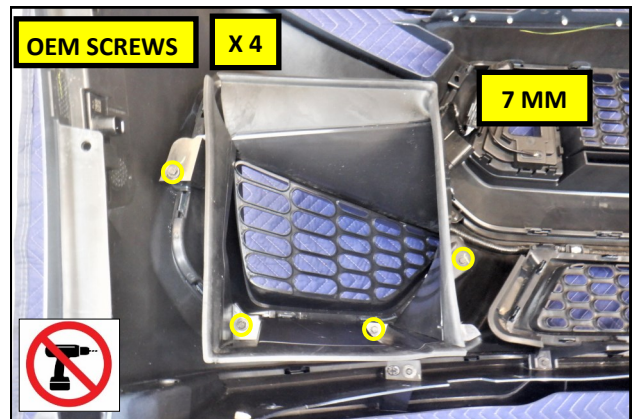

20. Using a 7 mm socket and the OEM screws removed in step 15, and reinstall the air duct as shown. Tighten the screws by hand to avoid over tightening.

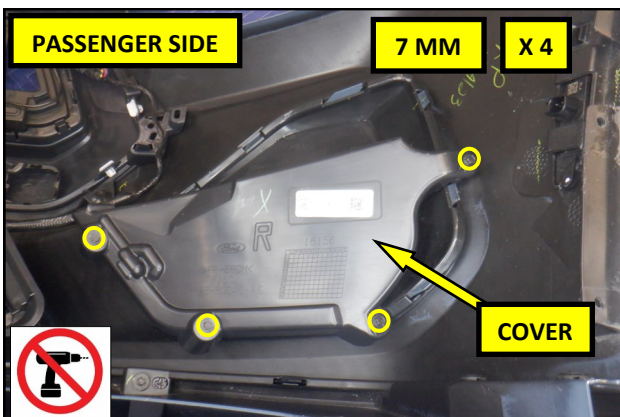

21. Using a 7 mm socket, remove the grille cover from the passenger side grille. Repeat steps 16-20 on the opposite side of the bumper cover and reinstall the cover using the OEM screws. Tighten the screws by hand to avoid over tightening.

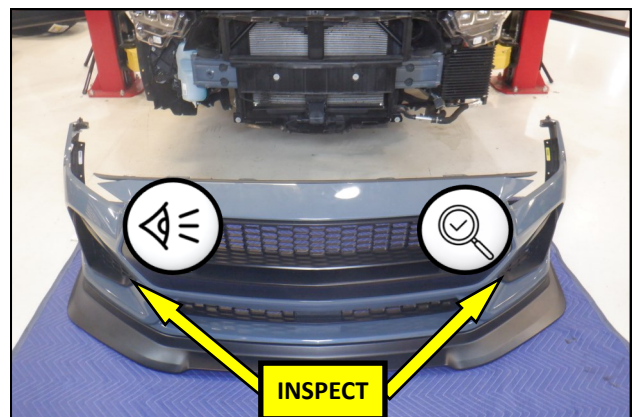

22. Inspect the installation from the front side of the bumper cover and confirm that all of the locking tabs are fully engaged and that there are no visible gaps.

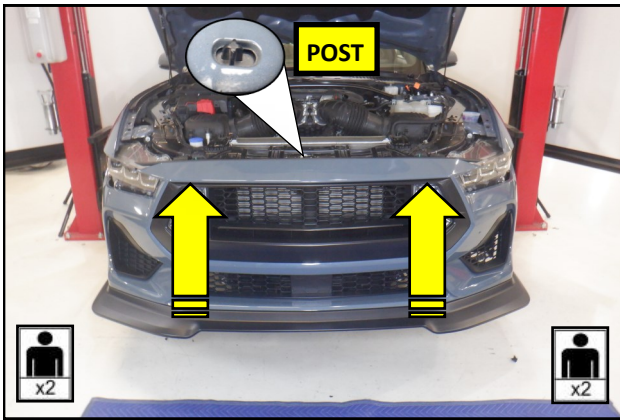

23. With the help of an assistant, lift the bumper cover back onto the vehicle and hang it onto the vehicle using the core support posts.

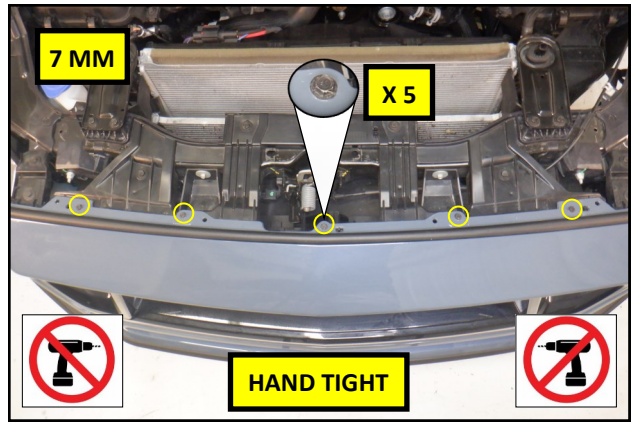

24. Using a 7 mm socket, reinstall the five OEM screws along the upper bumper cover. Tighten the screws by hand to avoid over tightening.

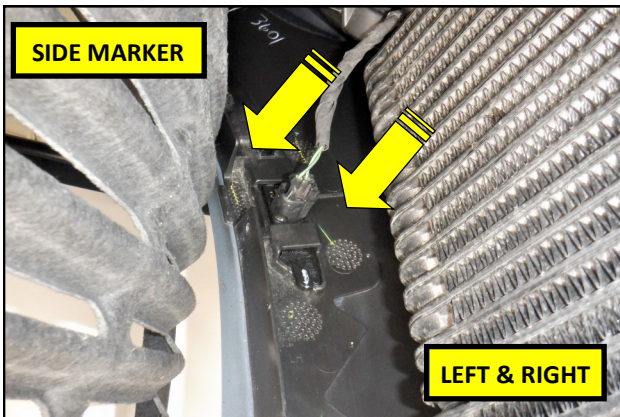

25. Reconnect the side marker lights on both sides of the vehicle.

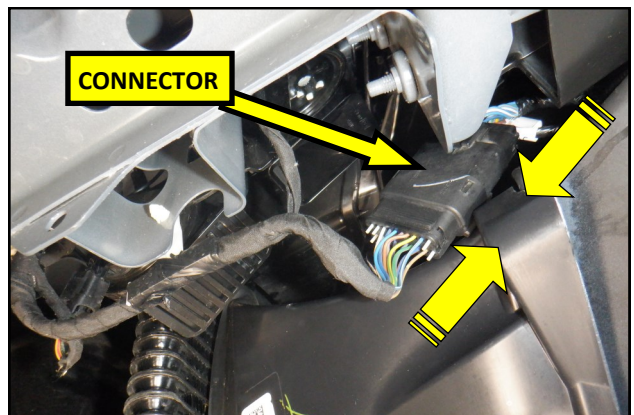

26. Reconnect the bumper wiring harness from step 7.

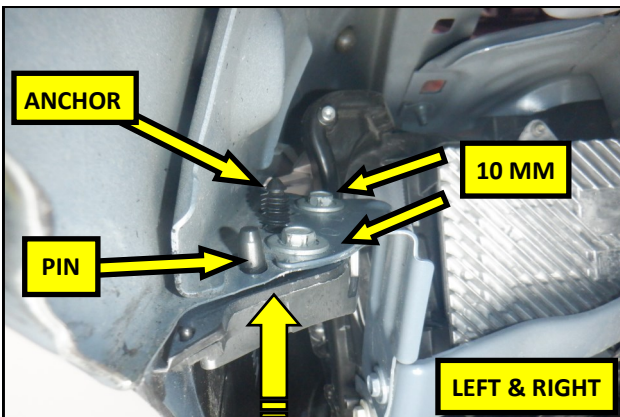

27. Lift the bumper cover up and press the fir tree anchor and guide pins into the fender. Using a 10 mm socket, reinstall the two OEM bolts to secure the bumper to the fender. Repeat this step on the opposite side of the vehicle.

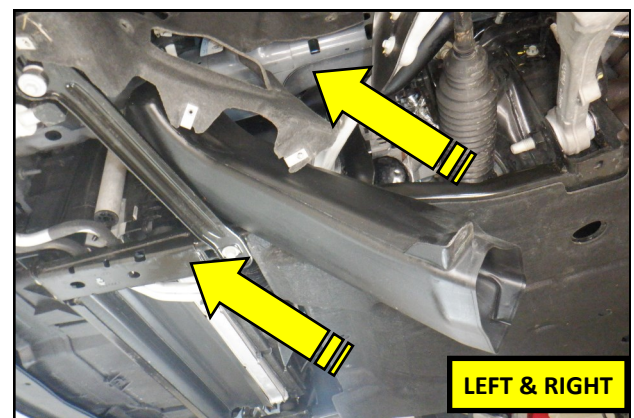

28. Reinstall the brake cooling ducts into the vehicle.

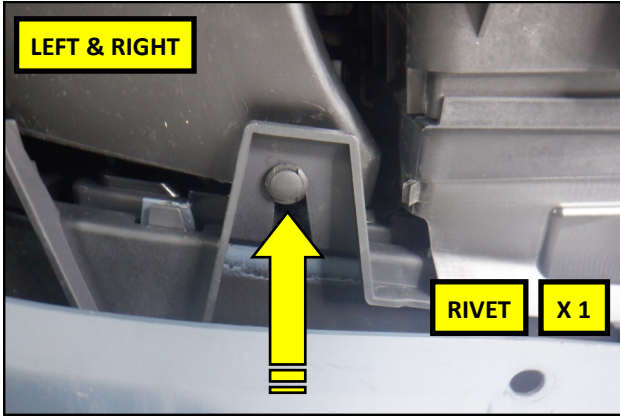

29. Reinstall the plastic rivet into the brake cooling duct inlet.

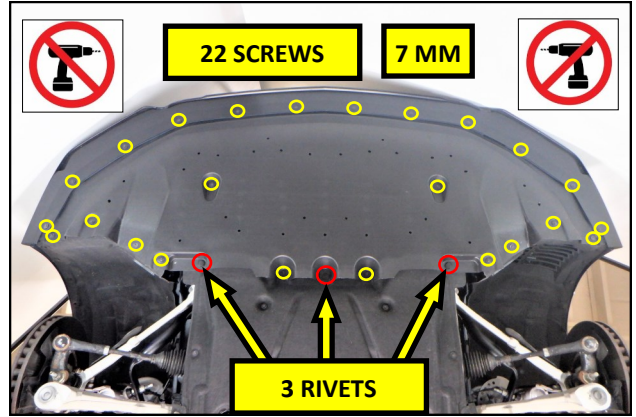

30. Lift the debris shield up and into the vehicle. Using a 7mm socket, reinstall the OEM screws and the plastic rivets. Tighten the screws by hand to avoid over tightening.

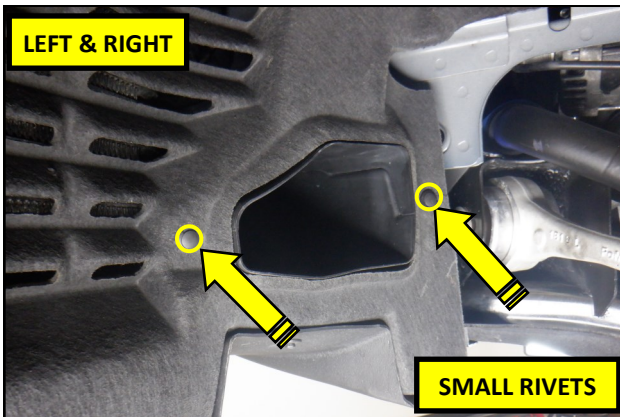

31. Reinstall the small plastic rivets into the cooling duct outlets.

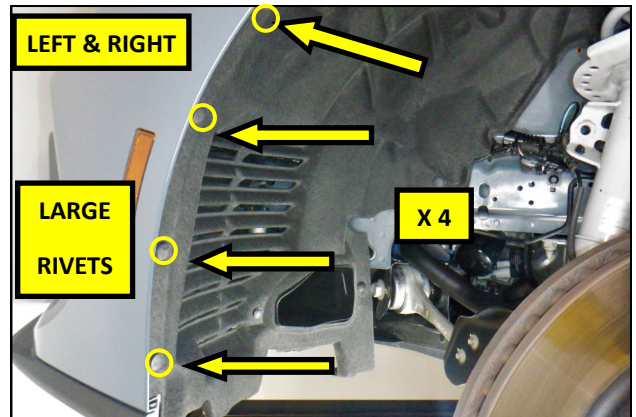

32. Unfold the fender liner and position it for reinstallation onto the bumper cover. Reinstall the 4, large plastic rivets into the front fender liners and cover.

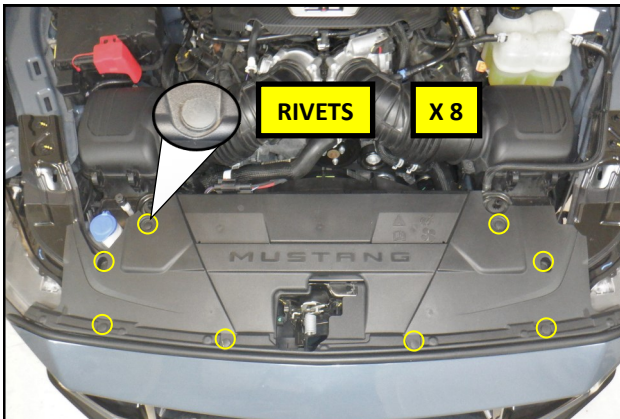

33. Reinstall the core support cover using the 8 OEM rivets removed in step 11.

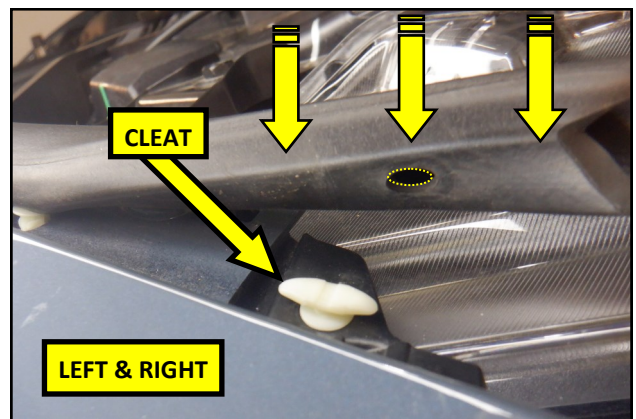

34. Carefully reattach the weatherstrip foam to the cleats on each side of the vehicle. Reinstall the wheels and tires to complete the installation.