

# Kit Details

27671



## HARDWARE LIST

Part #	Description	Qty	Part #	Description	Qty
72605	4pt Fast Air Manifold - 1/4"	1	21999	1/8" MNPT X 1/4" PTC Elbow	2
27042	Gen 3 Display	1	21633	Push Lock Valve	1
26498-002	Electrical Harness - FastAir	1	21585	1/4" Pipe Plug	1
24672	Fuse, spade 3 amp	1	20937	Polyurethane Filter Drain Hose	5ft
24547	Fuse, spade, 30 amp	1	20946	DOT 1/4" Air Line	60ft
24500	ATC Fuse holder w/ cap	2	17263	1/4-14 x 1 Self Tapping Screw	3
24645	16GA Butt Connector	1	18444	3/8" Flat Washer	8
24752	12-10GA Butt Connector	3	17188	3/8-16 x 1.25 Hex Cap Screw	4
24748	12GA Ring Terminal 3/8"	2	18435	3/8-16 Nylon Lock Nut	4
24524	Female Spade Terminal	1	11517	Miniature Filter	1
24595	12GA Female Spade Terminal	1	11217	P Clamp	1
24561	Adaptor, Mini Fuse	1	17173	1/4"-14 X 3/4" Self Tapping Screw	1
24542	ATC/ATO Fuse Adaptor	1	16380	VIAIR 380C Compressor (200 psi)	1
21043	1/4" MNPT X 1/4" PTC Elbow	1	11955	4 Gallon Aluminum Air Tank	1
21847	3/8" MNPT X 1/4" PTC Elbow	1	10466	8" Zip Tie	10
21737	3/8" Pipe Plug	1	10530	Air Line Cutter	1
21773	3/8" MNPT X 1/8" MNPT Adapter	1			



Missing or damaged parts? Call Air Lift customer service at (800) 248-0892 for a replacement part.

# Air Lift™ PERFORMANCE

## AutoPilot V2™ PATENT PENDING



### **AIR LIFT** **PERFORMANCE**™

## INSTALLATION GUIDE

For maximum effectiveness and safety, please read these instructions completely before proceeding with installation.

*Failure to read these instructions can result in an incorrect installation.*





# TABLE OF CONTENTS

<b>Introduction</b> .....	<b>2</b>
Notation Explanation .....	2
<b>Installing the AutoPilot V2 Kit</b> .....	<b>3</b>
Install Components .....	3
Install Harness .....	4
Install Air Lines .....	5
NPT Assembly Instructions .....	6
Helpful Tips: Air Line and Fittings .....	6
<b>Setup and Calibration</b> .....	<b>6</b>
System Calibration and Settings .....	7
<b>Program Presets</b> .....	<b>9</b>
<b>Operating the System</b> .....	<b>12</b>
<b>Troubleshooting Guide</b> .....	<b>13</b>
<b>Leak Testing and Detection</b> .....	<b>13</b>
<b>Electrical Schematic</b> .....	<b>14</b>
<b>AutoPilot V2 Remote Control Unit Dimensions</b> .....	<b>15</b>
<b>Manifold Template</b> .....	<b>17</b>
<b>16380 Compressor Template</b> .....	<b>19</b>
<b>Warranty and Returns Policy</b> .....	<b>21</b>
<b>Replacement Information</b> .....	<b>21</b>
<b>Contact Information</b> .....	<b>21</b>



# Introduction

The purpose of this publication is to assist with the installation, operation and troubleshooting of the AutoPilot V2 kit.

It is important to read and understand the entire installation guide before beginning installation or performing any maintenance, service or repair. The information includes step-by-step installation information, installation templates and a troubleshooting guide.

Air Lift Company reserves the right to make changes and improvements to its products and publications at any time. For the latest version of this manual, contact Air Lift Performance at (800) 248-0892 or visit our website at [www.airliftperformance.com](http://www.airliftperformance.com).

## NOTATION EXPLANATION

Hazard notations appear in various locations in this publication. Information which is highlighted by one of these notations must be observed to help minimize risk of personal injury or possible improper installation which may render the vehicle unsafe. Notes are used to help emphasize areas of procedural importance and provide helpful suggestions. The following definitions explain the use of these notations as they appear throughout this guide.

 **DANGER**

INDICATES IMMEDIATE HAZARDS WHICH WILL RESULT IN SEVERE PERSONAL INJURY OR DEATH.

 **WARNING**

INDICATES HAZARDS OR UNSAFE PRACTICES WHICH COULD RESULT IN SEVERE PERSONAL INJURY OR DEATH.

 **CAUTION**

INDICATES HAZARDS OR UNSAFE PRACTICES WHICH COULD RESULT IN DAMAGE TO THE MACHINE OR MINOR PERSONAL INJURY.

---

## NOTE

*Indicates a procedure, practice or hint which is important to highlight.*

---

# Installing the AutoPilot V2 Kit

## INSTALL COMPONENTS

### NOTE

*For a complete schematic, please see fig. 15. (pages 10-11)*

### CAUTION

BEST PRACTICE IS TO LOCATE THE MANIFOLD UNIT INSIDE THE VEHICLE. IF EXTERNAL MOUNTING IS DESIRED, THE MANIFOLD MUST BE LOCATED IN AN AREA SHIELDED FROM DIRECT WATER SPRAY FROM TIRES OR CAR WASHES. THE MANIFOLD SHOULD BE CONSIDERED “WATER RESISTANT” NOT “WATERPROOF”.

### *Layout*

1. Plan component location first. Ideally, the manifold should be located above the compressor and tank if possible to avoid compressor ingested water from gathering in the manifold. This is most important for vehicles operated in below freezing climates.
2. Prior to mounting components, check to make sure:
  - the electrical harness connections will reach the manifold and compressor.
  - the compressor leader hose will reach the tank.
  - the air lines will route cleanly through the vehicle without kinking or bending.

### NOTE

*Be sure to install all components as far as possible from any heat sources. Plan and prepare harness and air line routing thru the vehicle. Eliminate all sharp edges that could chafe. Use grommets when passing through compartment walls.*

### *Prepare and install the compressor*

1. Prepare the compressor intake. If the compressor body is mounted inside the vehicle, attach filter to port on end of compressor (fig. 15). If compressor is located outside the vehicle, snorkel inlet filter to dry location inside vehicle using components supplied with compressor.
2. Center punch and drill four holes using the template on page 19.
3. Attach using the hardware supplied with the compressor.

### NOTE

*If the harness must be lengthened, use properly sized butt connectors and wire. If extending the power/ground wires, use 8AWG wire minimum or contact Air Lift for more information.*

*The supplied harness is only capable of powering a single compressor. If installing dual compressors, a second dedicated power wire is required. Consult the Electrical Schematic section for proper wiring, and contact Air Lift for an optional second compressor harness (part number: 27679).*

### *Manifold*

1. Position the manifold in a desired location. Make sure the manifold mounting surface is flat.

### NOTE

*Mount the manifold to the body either horizontally (fig. 1a) or vertically with the ports facing toward the ground (fig. 1b). Do not mount the manifold upside down (fig. 1c). Proper manifold mounting will help prevent water from settling in areas sensitive to freezing.*

2. Fasten the manifold using the two self-tapping screws. **If the mounting surface is not flat, add washers to space the manifold up over surface irregularities.**
3. If needed, a manifold mounting template can be found on page 17.

This represents the top of the vehicle frame or any custom setup (and is the same for figures 1b and 1c).

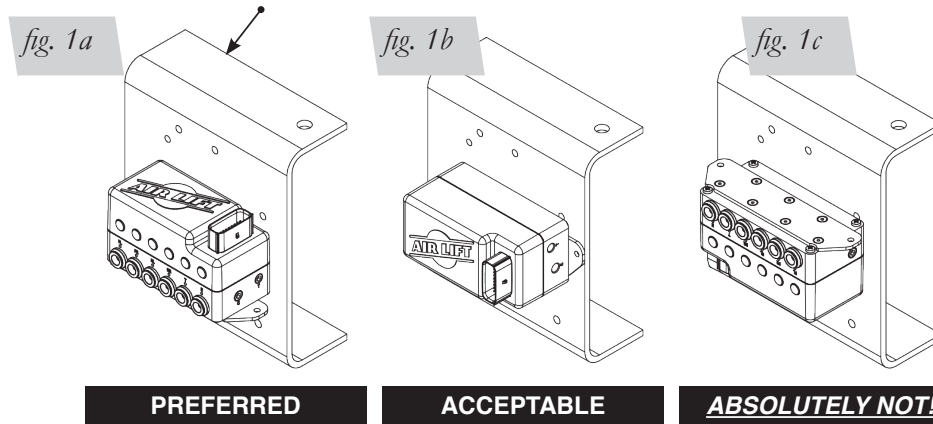

**NOTE**

*Air compressors intake moisture (humidity) from the outside air source and will deposit water in the air tank. The AutoPilot V2 system includes a filter that will greatly reduce the potential for moisture to enter the manifold, however, tanks must be regularly purged to eliminate the possibility of water entering the manifold. Be sure to provide easy access to tank drain/fill valve (preferably outside the vehicle). This is an automatic draining filter and does not need servicing. If you find this filter to be plugged, it will need to be replaced. If using an engine driven compressor, the life of the provided filter may be reduced due to the increased potential for oil being introduced into the system.*

**Tank pre-assembly** (see fig. 15)

1. Per the diagram on pages 10 and 11, install the filter to the tank with supplied fittings/adapters or remotely mount the filter using the supplied fittings, P-clamp and self tapping screw. Be sure to mount the filter in the correct orientation.

**NOTE**

*This is a one-way filter. The arrow at the top should be pointing in the direction of the air flow from the tank to the manifold (fig. 15b).*

*This is an automatic draining filter that does not require servicing. If you find this filter to be plugged, it will need to be replaced. The tank will need to be purged periodically to reduce/eliminate the potential of moisture entering the manifold.*

**Tank install** (see fig. 15)

1. Using the tank feet as a template, drill holes for hardware assembly.
2. Attach the tank using the supplied hardware.
3. Cut an appropriate length of hose from the manifold port T, to the PTC fitting on the filter.
4. Route the drain/fill air line with a schrader valve (preferably outside the vehicle).
5. Install the supplied drain tube (soft hose) to the bottom of the filter and route to a location outside of the vehicle.

**NOTE**

*When cutting plastic air line, only use a standard hose cutter like (Air Lift part number 10530) or razorblade. Cut all hose ends square and as smoothly as possible. See hose cutting tips on page 6.*

**INSTALL HARNESS**

1. Disconnect the battery ground while installing the system.
2. Compressor / manifold connections (see fig. 15)
  - Attach the manifold connector, it will “click” into place once fully seated.
  - Mount the compressor relay in a preferred location using a self-tapping screw.
  - Cut off the spade and eyelet from the compressor power and ground wires.
  - Strip 1/4” of wire casing from the compressor wires.
  - Strip 1/4” of wire casing from the black and pink harness wires.
  - NOTE: Use an appropriate terminal crimp tool to ensure a good connection.

- Using a butt connector attach the RED compressor wire to the PINK harness wire.
  - Using a butt connector attach the BLACK compressor wire to the BLACK harness wire.
  - Carefully apply heat (preferably with a heat gun) to seal these connections.
3. Battery / ignition connections (see fig. 15)
    - Identify the power, ground, + ignition leg of the harness.
    - Ground: 10AWG black wire; Power: 10AWG red wire; Ignition: 18AWG pink wire.
    - Route power and ground leg of the harness free from any heat source to the battery.
    - Using a butt connector attach the red wire to a fuse holder.
    - Attach an 3/8" eyelet to the other end of the fuse holder and attach to the positive battery (+) terminal.
    - Attach an 3/8" eyelet to the black wire and attach to the battery ground.
    - Route the 18AWG pink wire to a key switched IGNITION source that remains on during cranking. Examples include: ECU, fuel pump.

**NOTE**

*Do not select an accessory source. If the AutoPilot V2 display shuts off while starting the vehicle, this is not a true ignition source.*

- Using a butt connector attach the pink ignition wire to a fuse holder.
  - Select ignition source and attach the fused ignition wire.
  - Use fuse adaptors as necessary.
4. Display
    - Route the display cable as desired to the preferred operating location.
    - Attach the display cable to the main harness cable (small white 3 cavity connector).
  5. Reconnect the battery.

**INSTALL AIR LINES****NOTE**

*Use a standard hose cutter (Air Lift part number 10530) or razorblade. Cut all hose ends square and as smoothly as possible.*

1. Route and attach the air lines to the air springs.
  - Route air lines free from abrasive edges and heat sources.
2. Attach manifold port **FL** to the front, drivers side left spring.
3. Attach manifold port **FR** to the front, passengers side right spring.
4. Attach manifold port **RL** to the rear, drivers side left spring.
5. Attach manifold port **RR** to the rear, passengers side right spring.
6. Attach manifold port **T** to the PTC fitting previously installed on the filter.
7. Manifold port **E** is the exhaust port.
  - Port E can be left open, or routed to a preferred exhaust location.

**NOTE**

*Air lines should be pushed in firmly, with a slight back and forth rotational twist – check the connection by pulling on each line to verify a robust connection.*

*Release the air line from the fitting by releasing air, pushing on the line, depressing the ring towards the fitting, and then pulling the hose out of the fitting.*

**NPT ASSEMBLY INSTRUCTIONS**

1. Inspect the port and fitting ensuring both are free of contaminants and excessive burrs and nicks.
2. Apply a stripe of liquid pipe sealant around the male threads leaving the first two threads uncovered.
3. Screw finger tight into the port.
4. Wrench tighten the fitting to the correct turns past finger tight position (see table 1 located on page 6).

**CAUTION**

**NEVER BACK OFF AN INSTALLED PIPE FITTING TO ACHIEVE PROPER ALIGNMENT. LOOSENING INSTALLED PIPE FITTINGS WILL CORRUPT THE SEAL AND CONTRIBUTE TO LEAKAGE AND FAILURE.**



Torque Specifications		
Fitting Size	Turns Past Finger Tight	Torque lb/ft
1/8" NPT	1.5 - 3.0	12
1/4" NPT	1.5 - 3.0	25
3/8" NPT	1.5 - 3.0	40
1/2" NPT	1.5 - 3.0	54
3/4" NPT	1.5 - 3.0	78
1" NPT	1 - 2.5	112
1 1/4" NPT	1 - 2.5	154
1 1/2" NPT	1 - 2.5	211
2" NPT	1 - 2.5	300

*Table 1*

### HELPFUL TIPS: AIR LINE AND FITTINGS

1. Minimum hose bend radius
  - 3/8" hose = 1.5" hose bend radius.
  - 1/4" hose = 1" hose bend radius.
2. Hose to fitting
  - No side loading on fitting from hose.
  - Hose straight for 1" before bending.
3. Hose cutting
  - Cut hose perpendicular to hose length.
  - Inspect hose for scratches that run lengthwise on hose prior to insertion.
  - Use proper hose cutter, cigar cutter, or razor on flat surface.
4. DOT/SAEJ844 air brake hose data
  - Maximum working pressure of 175 PSI.
  - Not to be used for frame (body) to un-sprung mass connection, use a braided leader hose for this moving connection.

Compressor Tank Pressure		
Viair	Air Lift P/N	Max. Tank Pressure
380C	16380	175
400C	16400	150
444C	16444	175
450C	16450	150
480C	16480	175

*Table 2*

## Setup and Calibration

AutoPilot V2 is an advanced pressure-based air suspension control system, that uses state-of-the-art software algorithms to calibrate or map the control system to your vehicle. Once the system is calibrated, the algorithm predicts required "valve open time" to move the air suspension to achieve preset target pressures. AutoPilot V2 has 8 programmable presets, allowing the user to input 8 different combinations of the 4 corner air spring pressures.

After installing AutoPilot V2 in your vehicle, please follow the steps below to properly setup your new system. If changes are made after installing and calibrating the system such as changes to air springs, lines, tank, compressor, or other vehicle modifications, the system must be recalibrated to maintain accuracy.

## SYSTEM CALIBRATION AND SETTINGS

1. Key-on/power up, and compressor should come on to fill the tank. Check to make sure system is triggered by IGNITION source. While starting the engine, the system should be ON. If not, please refer back to the “Install Harness” section.
2. Press buttons 1 and 5 simultaneously (1+5) and hold for 5-10 seconds until settings and diagnostics mode main page appears (fig. 3).

fig. 2

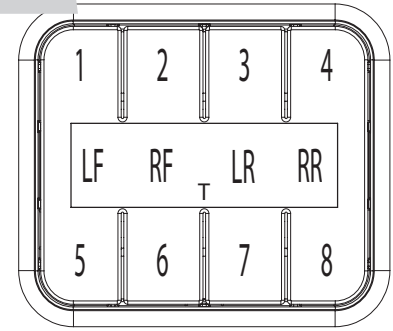

Button Definition

### Tank Adjust (Maximum System PSI)

Press button 1 (TANK ADJUST). Set tank pressure preference by pressing MAX up/down buttons simultaneously (fig. 4). The MAX value sets compressor cut-off pressure. Press buttons (1+5) simultaneously to exit to settings and diagnostics mode.

fig. 3

```

1. TANK ADJUST
2. CALIBRATE
3. BACKLIGHT
4. PRESET MAIN ▾
    
```

### NOTE

*MIN tank pressure will follow MAX within 15 PSI to provide further accuracy.*

*If tank MAX settings are changed, a system recalibration is necessary for optimal performance. Max tank pressures for various compressors can be found in table 2.*

fig. 4

```

      ▲
TANK MAX=175
      ▼
    
```

### Calibrate to your vehicle

Press button 2 to enter CALIBRATE (fig. 3). Press button 1 SYSTEM CAL (fig. 5), follow instructions to calibrate AutoPilot V2 system to your vehicle. Once calibration is complete, Press buttons (1+5) simultaneously to exit to settings and diagnostics mode.

fig. 5

```

CALIBRATION MENU
1. SYSTEM CAL
2. ADJUST SYSTEM
    
```

### CAUTION

DURING CALIBRATION THE SYSTEM WILL AUTOMATICALLY DEFLATE TO 0 PSI AND RAISE TO 100 PSI ON EACH AXLE AUTOMATICALLY. IF WHEELS EXTEND BEYOND FENDERS, VEHICLE DAMAGE MAY RESULT. CALIBRATION ON NARROW WHEELS THAT TUCK INSIDE THE FENDERS IS RECOMMENDED. ALSO, MAKE SURE VEHICLE BODYWORK WILL NOT BE HARMED IF ONE END IS RAISED TO 100 PSI AND THE OTHER IS AT ZERO. IF DAMAGE IS POSSIBLE, IT MAY BE BEST TO CALIBRATE BY SETTING VEHICLE ON BLOCKS OF WOOD (SAME HEIGHT) TO GIVE THE BODYWORK MORE CLEARANCE.

### Backlight Setting

Press button 3 to enter BACKLIGHT (fig. 3). Set display backlight to your preference by pressing the + and – on R (Red), G (Green), B (Blue) (fig. 6). Press buttons (1+5) simultaneously to exit to settings and diagnostics mode.

fig. 6

```

+ + +
BACKLIGHT
R G B
- - -
    
```

**Automatic Preset Maintenance**

Press button 4 (fig. 3) to enter PRESET MAINTAIN. Press button 8 to turn ON or OFF (fig. 7). When ON, this function actively monitors air spring pressure and fills to maintain active preset pressure when average pressure drops below a threshold due to a system leak.

fig. 7



**NOTE**

*This function will not exhaust pressure. If air spring pressure is higher than preset target, only the operator pressing the preset button again will activate the system to exhaust air spring pressure (for safety). Press buttons (1+5) simultaneously to exit.*

*PRESET MAINTAIN should be off for performance/track driving or if operating in extremely hilly areas.*

**Compressor Test / Run Time**

Press button 5 to run a compressor test (fig. 8). This function will exhaust the tank to the specified MIN tank pressure, then turn ON the compressor and measure its inflate time to achieve MAX pressure (fig. 9). AutoPilot V2 will record this fill time, allowing the operator to compare future fill times to determine compressor performance. Press buttons (1+5) simultaneously to exit. Press button 6 (fig. 8) to view the number of hours the compressor has been running.

fig. 8

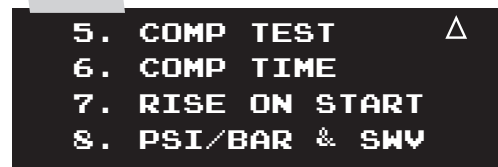

fig. 9

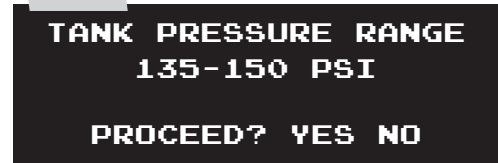
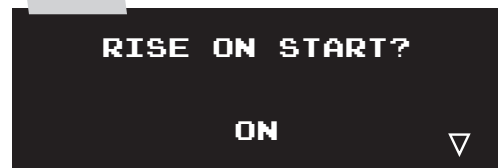

fig. 10



**Rise on Start**

Press button 7 (fig. 8) to enter RISE ON START (fig. 10). This function will automatically activate valves to achieve preset 1 target pressures when the vehicle is keyed-on. This function allows the operator to drive away seconds after vehicle is started. Press buttons (1+5) simultaneously to exit.

**NOTE**

*This function only operates when the start-up pressures are BELOW the Preset 1 target pressures. The system will not deflate to achieve Preset 1 target*

**Set Units (PSI / BAR)**

1. Press button 8 (fig. 8) to toggle between PSI and BAR pressure units and check software version. Press buttons (1+5) simultaneously to exit.
2. Press buttons (1+5) simultaneously to exit settings and diagnostics – you are now ready to create presets!

**NOTE**

*BAR stands for DeciBar values.*

# Program Presets

## Program Preset 1

**NOTE**

*Preset 1 should always be entered as the desired ride pressure for the RISE ON START function.*

Determine desired ride pressures: press buttons (1+5) simultaneously to toggle display to MANUAL mode. Manually activate each corner (see MANUAL mode section page 13) to achieve desired “normal driving” ride pressure (fig. 11). Program preset 1: press buttons (1+5) simultaneously to toggle display to PRESET mode (fig. 12). Press and hold button 1 for 3 seconds to set preset 1. Release button and actual air spring pressures will appear (fig. 12). Fine-tune the pressures by pressing up/down buttons. Press and hold to scroll. Press buttons (1+5) simultaneously to save and exit.

## Program Presets 2-8

You are now free to program the additional 7 presets to desired pressures. Typical presets can be:

- “Low”: set pressures to the lowest possible pressures for extreme low driving stance.
- “Front up”: for speed bump or driveway clearance.
- “Rear up”: for added load of passengers, equipment.
- “Play”: for those that want to enjoy their air suspension freedom, AutoPilot V2 has a special function that recognizes side-to-side presets. When left side pressures are equal, and right side pressures are equal but >25PSI different than left, the algorithm will activate side to side instead of front to back. It will also equalize all air spring pressures when exiting the “play” preset, conserving air by using the high pressure side to inflate the low pressure side. Pairing two “play” presets together allows side-to-side activation that consumes far less air than manual mode activation would consume.

fig. 2

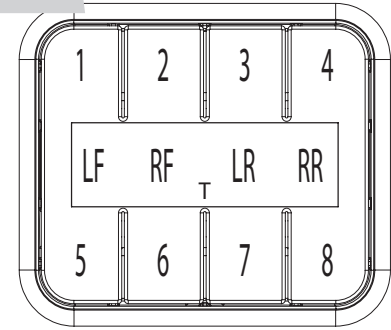

**Button Definition**

fig. 11



fig. 12

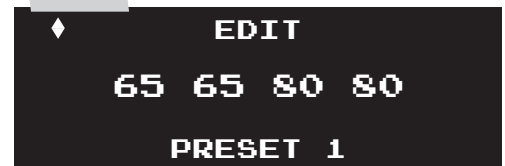

fig. 13



fig. 14



**Sample Pressure Layouts for Play Mode (figs. 13 & 14)**

fig. 15

### Connect direct to battery

**Preferred**

NOTE: If not run to battery, voltage drop may reduce system performance and durability.

### Ignition Source (on while cranking)

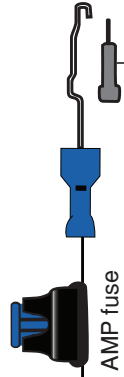

Examples:

- ECU • Fuel pump • etc.

### Relay schematic reference

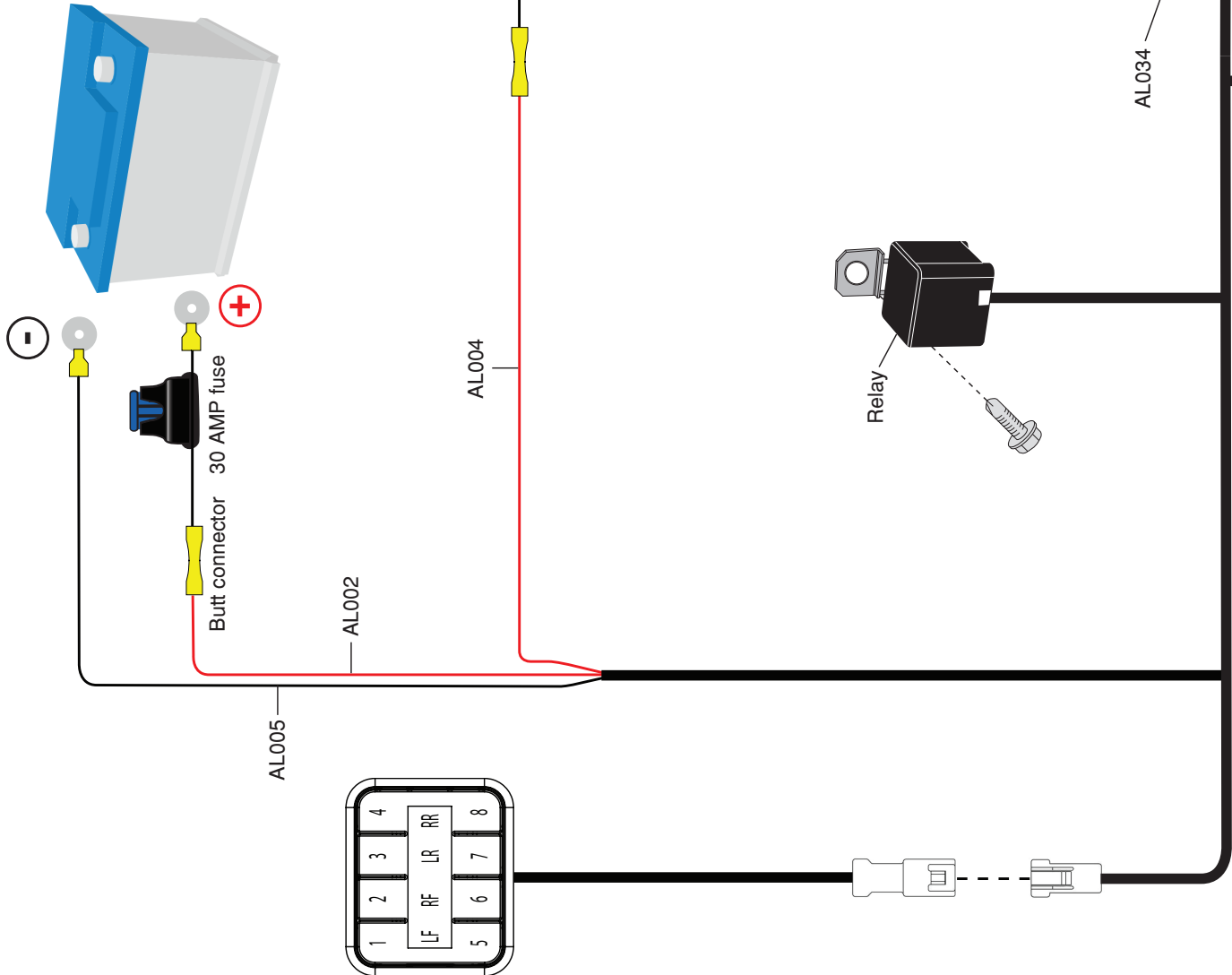
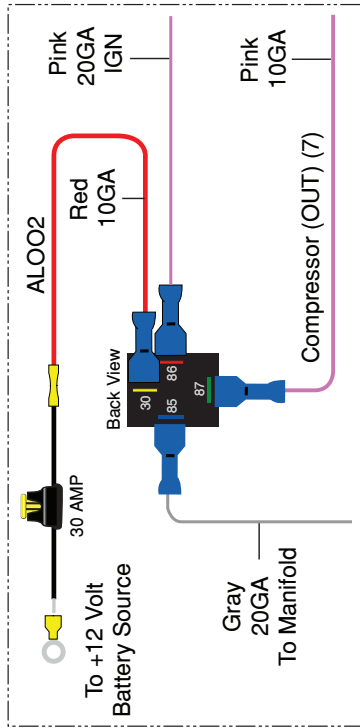

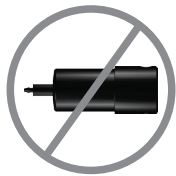
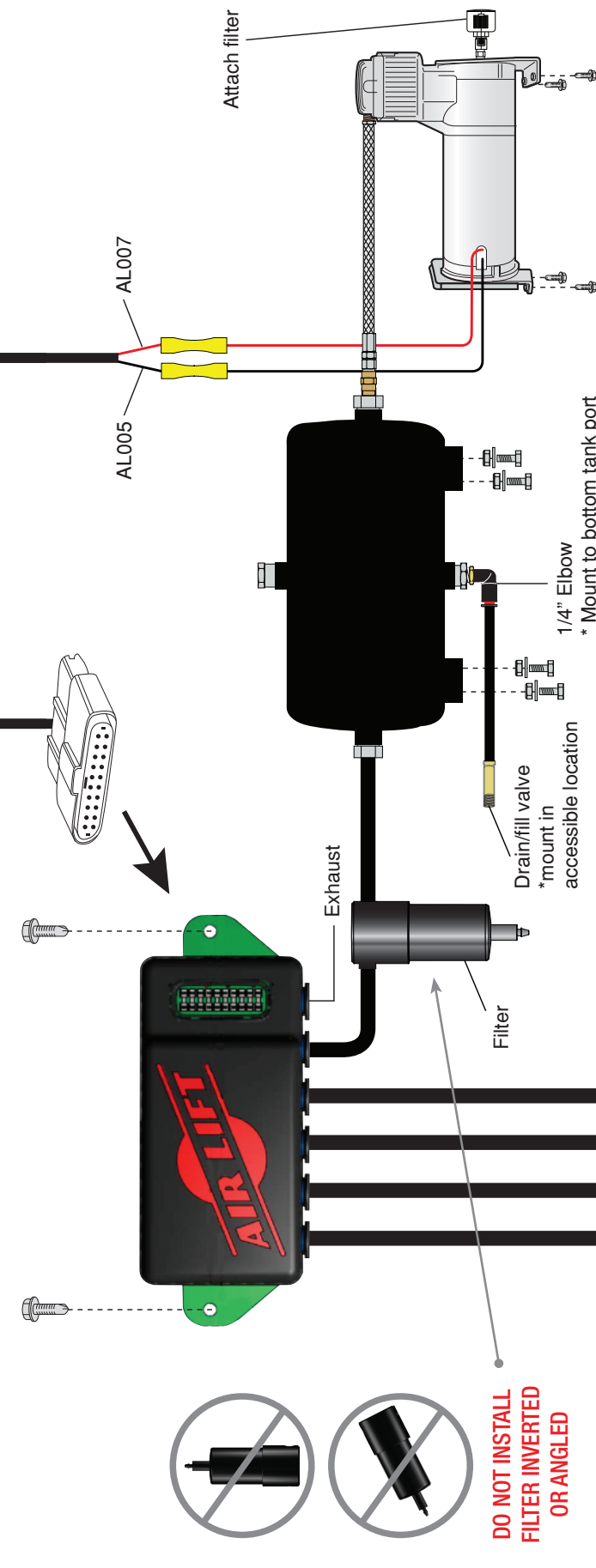

**DO NOT INSTALL  
FILTER INVERTED  
OR ANGLED**

## FILTER INSTALLATION OPTIONS

### OPTION #1 - INSTALL TO TANK

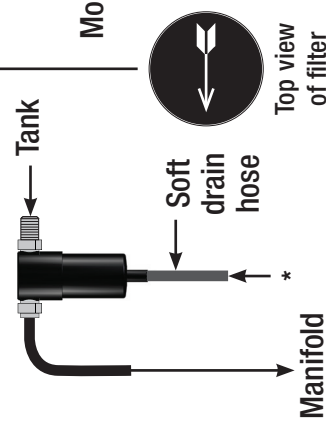

### OPTION #2 - REMOTELY MOUNT\*\*

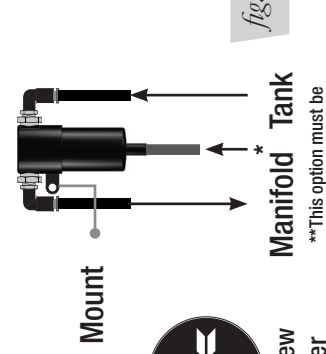
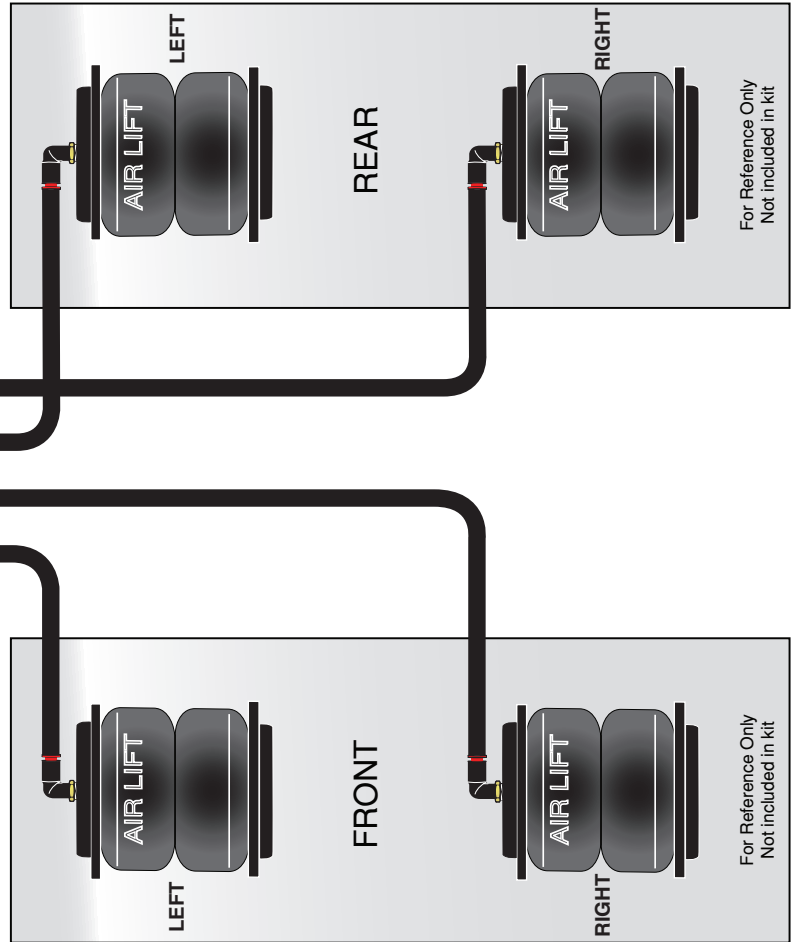
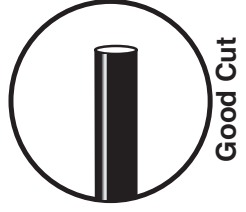

fig. 15b

\*This is a moisture drain and must drain to the outside of the vehicle.

## AIR LINE CUTTING

NOTE: Air Lift recommends using a hose cutting tool to ensure a proper cut (Air Lift part number 10530). If a hose connection has been disconnected the hose must be trimmed 1/2" back to provide for a leak free seal.



# Operating the System

Now that your system is set up, it's time to use it. If changes are made after installing and calibrating the system such as changes to air springs, lines, tank, or compressor, the system must be recalibrated to maintain system accuracy.

There are two operational modes: PRESET and MANUAL. Pressing buttons (1+5) simultaneously will toggle between modes. After 10 seconds of non-use, the display enters standby where the LCD dims. Any button hit will "wake-up" the display and allow users to activate the system. See mode operation below for more details.

## PRESET Mode

1. If display is sleeping, press any button once to "wake up" the display. If display is illuminated, go to the next step. Press of any button will display the programmed preset pressures for that button. Users can quickly view each preset prior to activating to make sure they are selecting the desired preset.
2. A 2<sup>nd</sup> button press of the same preset button within 2 seconds will activate it. The system will iterate up to 6 times to achieve the preset target pressures by +/- 3 PSI. The display shows PLEASE WAIT as it iterates, then will flash SUCCESSFUL when achieved or UNSUCCESSFUL if not able to achieve the target pressure window.
3. Micro adjust to ±1 PSI: If more accuracy is desired, double press the same preset and the system will refine pressures closer to target. This is often necessary when target preset pressures are LOWER than current pressure. Accuracy can be improved by rolling the vehicle straight while activating the preset.

### NOTE

*If the system indicates UNSUCCESSFUL, refer to troubleshooting guide on page 13.*

## PRESET Mode: Improve Accuracy

If system reads SUCCESSFUL but pressures are consistently lower or higher than target, you can improve first attempt accuracy by going to Calibration Menu (fig. 5) and pressing button 2. Adjust the ADJ value to a higher number if first attempt pressures are lower than target. Adjust the value to a lower number if first attempt pressures are higher than target.

### CAUTION

WHEN A PRESET IS ACTIVATED THAT LOWERS THE VEHICLE SIGNIFICANTLY BELOW DRIVING HEIGHT, BE SURE TO HAVE THE FRONT WHEELS STEERED STRAIGHT AHEAD TO AVOID FENDER TO TIRE DAMAGE!

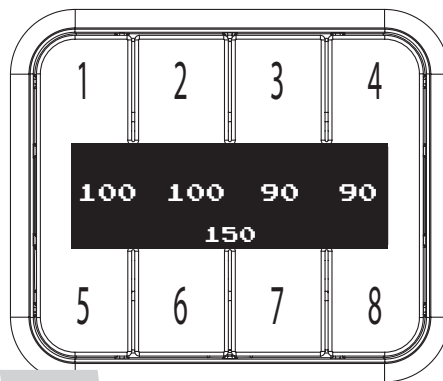

fig. 16

**PRESET Mode**

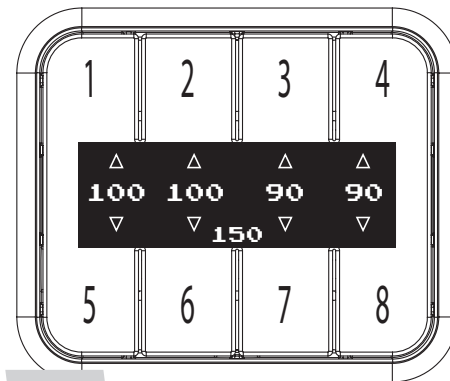

fig. 17

**MANUAL Mode**

**MANUAL Mode**

1. MANUAL mode allows the user to fill or exhaust each spring independently. The display will show arrows above and below the pressures to indicate manual control mode (fig. 17). The arrow will be solid when the spring is filling/exhausting, and outlined when not active.
2. The system detects button press time. For a very short (<0.1sec) duration press, the system will open the valves for a defined “burst”, changing pressure minimally so users can fine-tune their pressures. For a longer than 0.1 sec duration press, the valves open as long as you hold the button down. If a button is held active, the fill/exhaust will time out after 10 seconds.
  - Fill springs: buttons 1 - 4, Exhaust springs: buttons 5 - 8

# Troubleshooting Guide

For further technical assistance please contact our customer service department by calling (800) 248-0892, Monday through Friday. For calls from outside the USA or Canada, our local number is (517) 322-2144.

PROBLEM	CAUSE	SOLUTION
<i>Compressor doesn't run</i>	There is a blown fuse or relay, bad ground, or poor electrical connections.	Replace the fuse, check the ground wire, or check the compressor connector
<i>Compressor runs all the time.</i>	The compressor relay is defective or there is a leak.	Replace the relay or locate the leak and repair.
<i>Air spring or tank leak.</i>	Fitting seal or air line is compromised.	Check to make sure air lines are seated in connectors. Inspect fittings with soapy water. Trim hose or re-seal fitting.
<i>Nothing happens when the vehicle is key-on ignition active</i>	There is a blown fuse or a poor connection.	Replace the fuses and check the electrical connections.
<i>The display does not light up.</i>	There is a blown fuse or a poor connection.	Replace the fuses and check the electrical connections.
<i>Compressors runs all the time but doesn't fill the tank.</i>	Compressor in-line check valve fitting has been overtorqued.	Loosen fitting and check again. Replace if needed.
<i>Display shows UNSUCCESSFUL.</i>	“Double Click” for Preset not completed within 2 second window.	If display is in sleep mode, click once to “Wake Up”, then “Double Click” desired preset within 2 seconds of each press.
	Calibration may need to be adjusted or system may need to be recalibrated.	Adjust ADJ value or recalibrate system to reduce number of iterations.
	Tank pressure settings changed.	Attempt recalibration.
	Vehicle load changed significantly.	
<i>Display shows PRESSURE SENSOR FAILURE.</i>	ECU has detected a pressure sensor operating incorrectly.	Only manual mode can be used to operate suspension. Contact customer service immediately to resolve the problem.

# Leak Testing and Detection

**Leak detection**

1. A leak can be defined as a loss of pressure of more than 5 psi over an 8 hour period. Be aware that ambient temperature change has an effect on pressure that may seem like a leak. For example: a change of 10deg Fahrenheit up or down from your baseline will have an approximate gain or loss of indicated pressure of 2 psi. If a leak is suspected after including any temperature change, then proceed to #2.
2. Spray soapy water (1/5 Dawn brand dish soap to 4/5 water) on suspect fittings and hose connections and look for any bubbling caused by air leakage.
3. Fix leaking connection (review pg. 6 for help on NPT fittings and air line connections).
4. Wipe down sprayed connections with rag to remove any residual soapy water.

**NOTE**

*Dawn brand dish soap will not corrode the metals (aluminum, brass, steel) with which it comes into contact.*



# Electrical Schematic

## AUTOPILOT V2 GEN 3 PRESSURE CONTROL

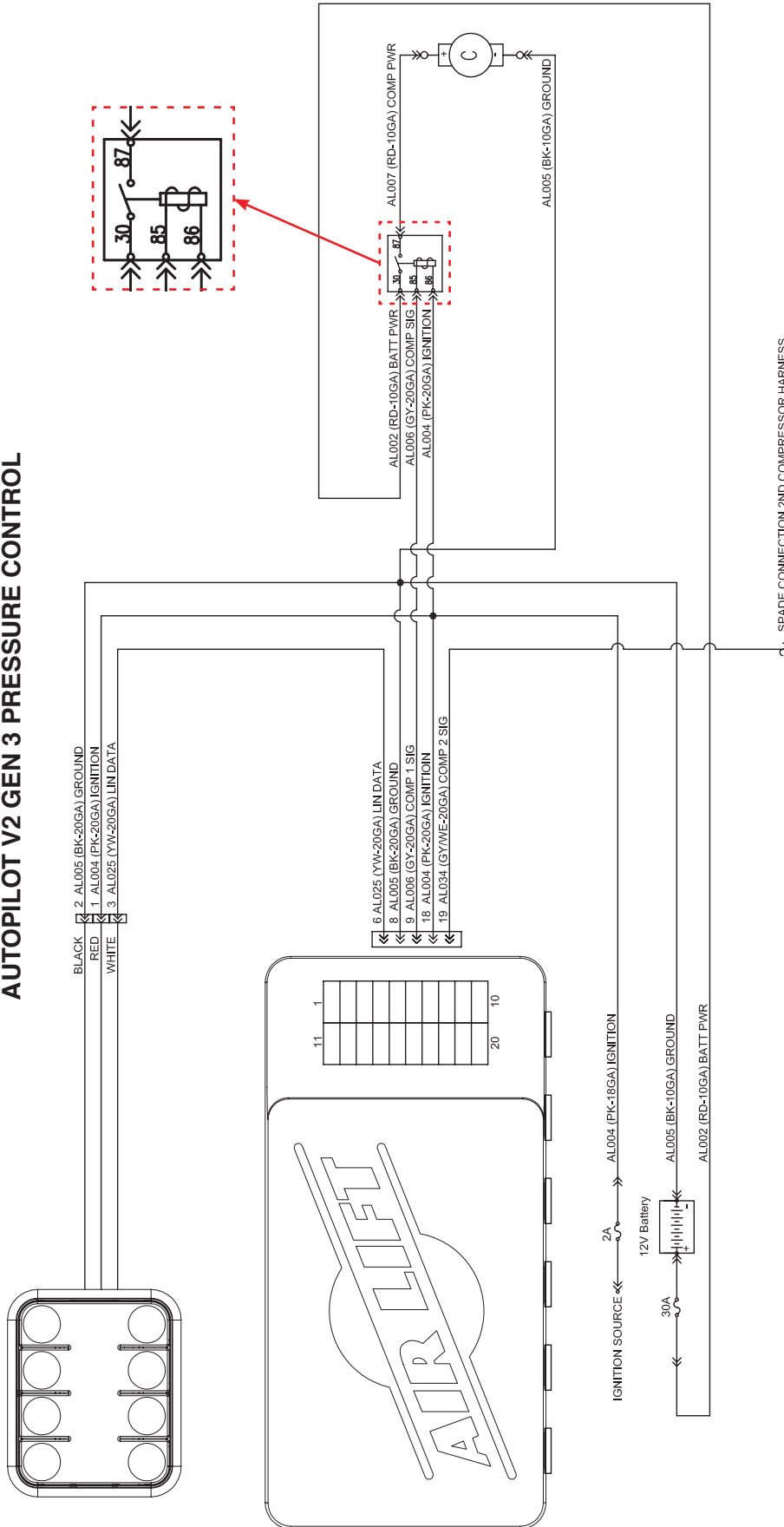

## AUTOPILOT V2 SECOND COMPRESSOR HARNESS\*

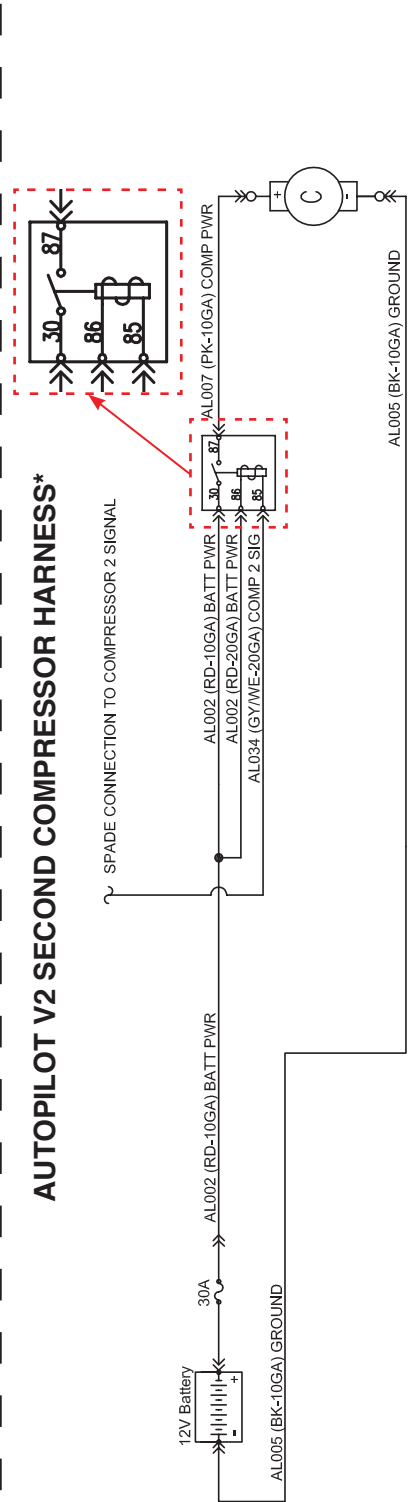

\* Sold separately  
Air Lift Part Number 27679

fig. 18

# AutoPilot V2 Remote Control Unit Dimensions

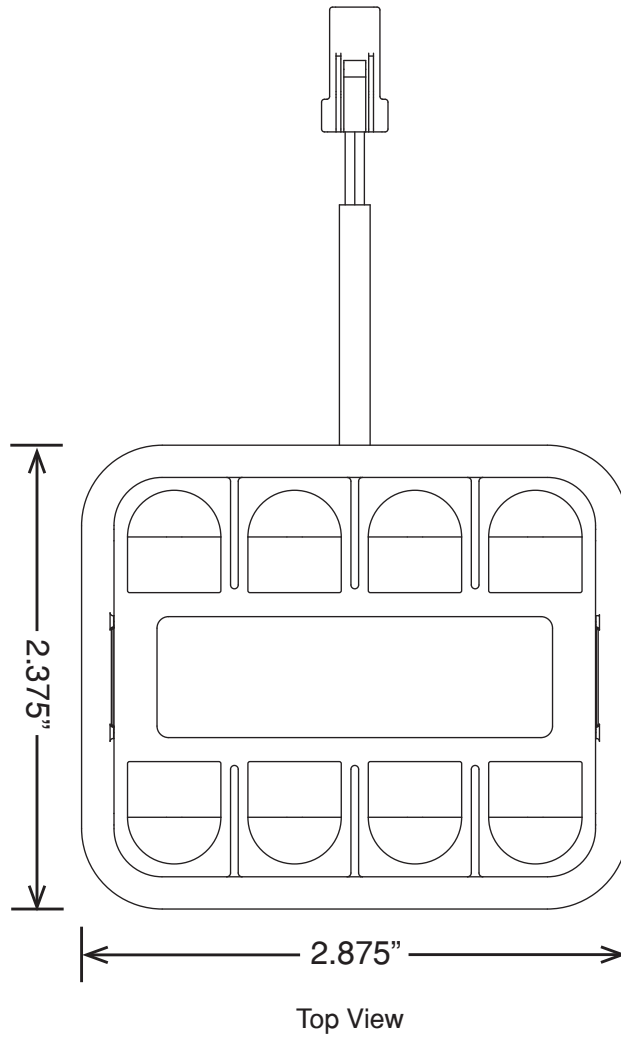

# Notes

# Manifold Template

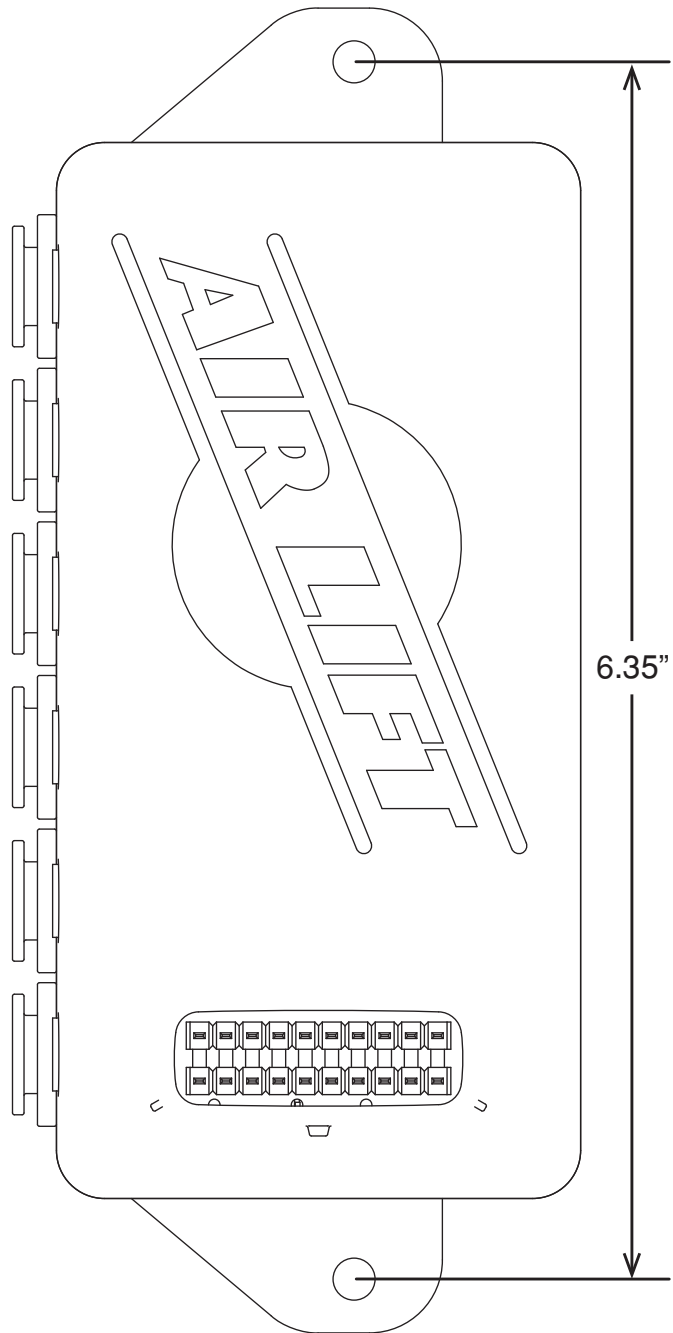

# Notes

# 16380 Compressor Template

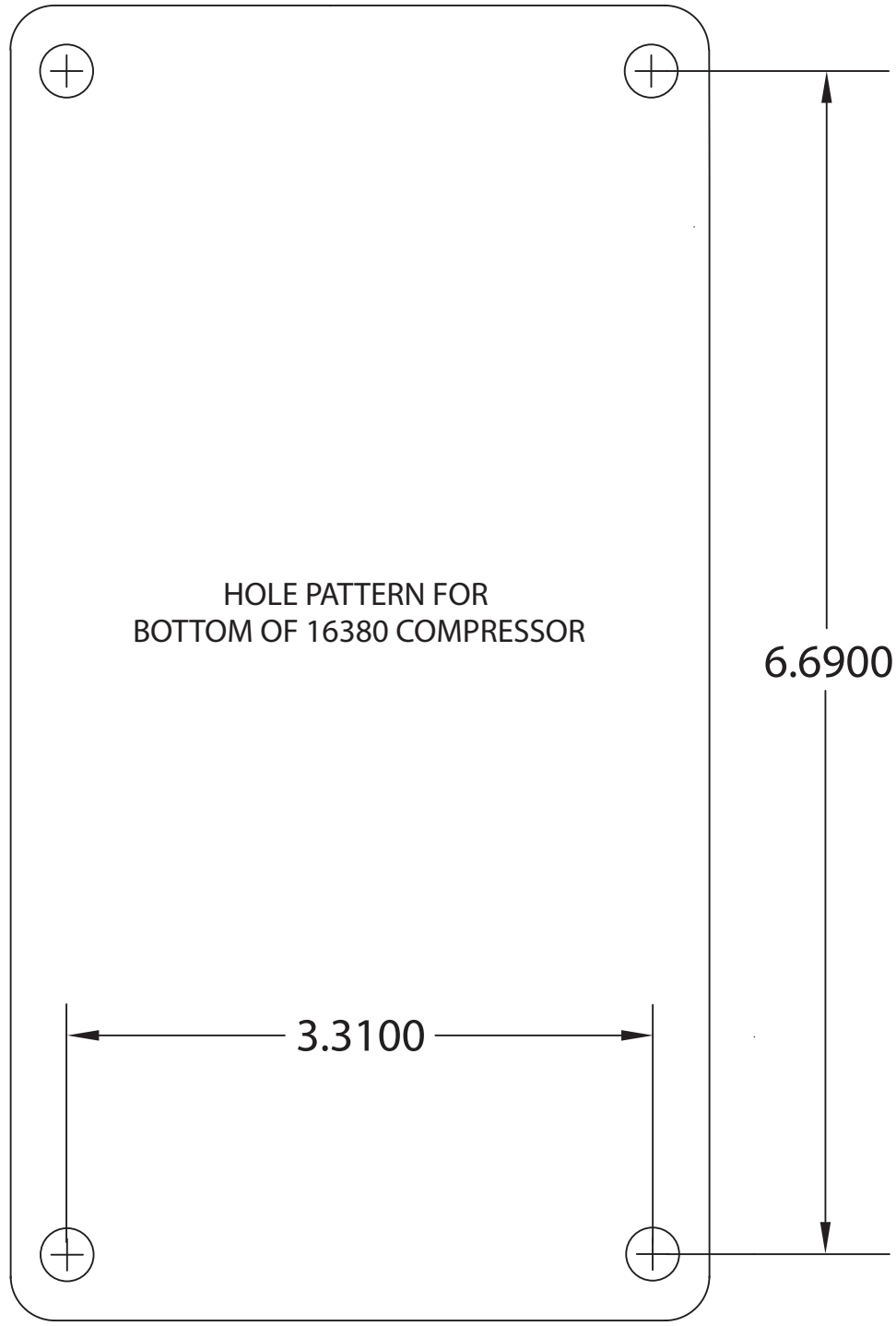

# Notes

---

# Warranty and Returns Policy

Air Lift Company warrants its performance products for one year to the original purchaser against manufacturing defects one year from the date of purchase when used on cars and trucks as specified under normal operating conditions. The warranty does not apply to products that have been improperly applied, improperly installed, or which have not been maintained in accordance with installation instructions furnished with all products. The consumer will be responsible for removing (labor charges) the defective product from the vehicle and returning it, transportation costs prepaid, to the dealer from which it was purchased or to Air Lift Company for verification.

Air Lift will repair or replace, at its option, defective products or components. A minimum \$10.00 shipping and handling charge will apply to all warranty claims. Before returning any defective product, you must call Air Lift at (800) 248-0892 in the U.S. and Canada (elsewhere, (517) 322-2144) for a Returned Materials Authorization (RMA) number. Returns to Air Lift can be sent to: Air Lift Company • 2727 Snow Road • Lansing, MI • 48917.

Product failures resulting from abnormal use or misuse are excluded from this warranty. The loss of use of the product, loss of time, inconvenience, commercial loss or consequential damages is not covered. The consumer is responsible for installation/reinstallation (labor charges) of the product. Air Lift Company reserves the right to change the design of any product without assuming any obligation to modify any product previously manufactured.

This warranty gives you specific legal rights and you may also have other rights that may vary from state-to-state. Some states do not allow limitations on how long an implied warranty lasts or allow the exclusion or limitation of incidental or consequential damages. The above limitation or exclusion may not apply to you. There are no warranties, expressed or implied including any implied warranties of merchantability and fitness, which extend beyond this warranty period. There are no warranties that extend beyond the description on the face hereof. Seller disclaims the implied warranty of merchantability. (Dated proof of purchase required.)

## Replacement Information

If you need replacement parts, contact the local dealer or call Air Lift customer service at (800) 248-0892. Most parts are immediately available and can be shipped the same day.

**Contact Air Lift Company customer service at (800) 248-0892 first if:**

- Parts are missing from the kit.
- Need technical assistance on installation or operation.
- Broken or defective parts in the kit.
- Wrong parts in the kit.
- Have a warranty claim or question.

**Contact the retailer where the kit was purchased:**

- If it is necessary to return or exchange the kit for any reason.
- If there is a problem with shipping if shipped from the retailer.
- If there is a problem with the price.

## Contact Information

If you have any questions, comments or need technical assistance contact our customer service department by calling (800) 248-0892, Monday through Friday. For calls from outside the USA or Canada, our local number is (517) 322-2144. You may also contact customer service anytime by e-mail at [techsupport@airliftperformance.com](mailto:techsupport@airliftperformance.com).

For inquiries by mail, our address is PO Box 80167, Lansing, MI 48908-0167. Our shipping address for returns is 2727 Snow Road, Lansing, MI 48917.

You may also contact our sales team anytime by e-mail at [sales@airliftperformance.com](mailto:sales@airliftperformance.com) or on the web at [www.airliftperformance.com](http://www.airliftperformance.com).



## Need Help?

Contact our customer service department by calling (800) 248-0892, Monday through Friday. For calls from outside the USA or Canada, our local number is (517) 322-2144.



*Thank you for purchasing Air Lift Performance products!*

Air Lift Company • 2727 Snow Road • Lansing, MI 48917 or PO Box 80167 • Lansing, MI 48908-0167  
Toll Free (800) 248-0892 • Local (517) 322-2144 • Fax (517) 322-0240 • [www.airliftperformance.com](http://www.airliftperformance.com)

Printed in  
the USA